

ROLLING GRILLES

# VISIONAIRE<sup>®</sup> MICROCOIL<sup>®</sup> GRILLE

Models ESG10C & ESG12C

## MEASURE THE WIDTH AND HEIGHT OF THE OPENING

### DOOR SIZE AND AREA

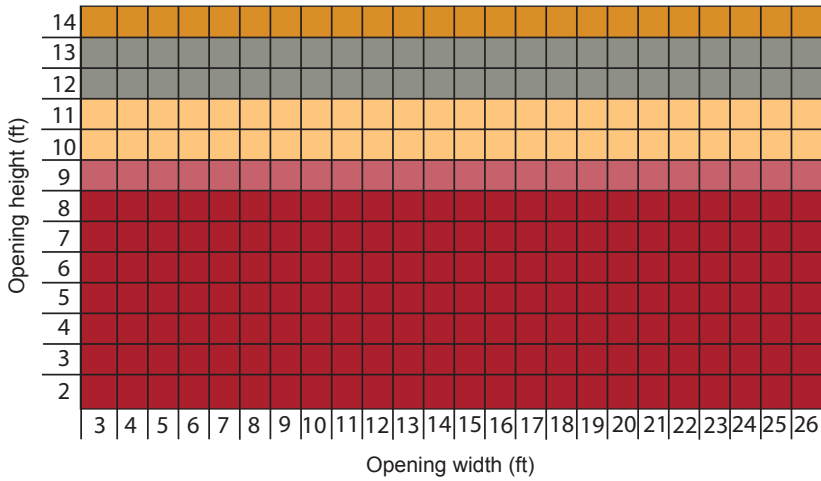

### COMPONENT DIMENSIONS

	A	B	C	D	E
	10 1/2"	14 1/2"	FOW = 6" BJ = 6"	FOW = 6 1/2" BJ = 6 1/2"	5"
	10 3/4"	14 3/4"			
	11"	15"			
	11 1/2"	15 1/4"			
	11 3/4"	15 3/4"			

Dimensions provided are for stainless steel and aluminum curtains.

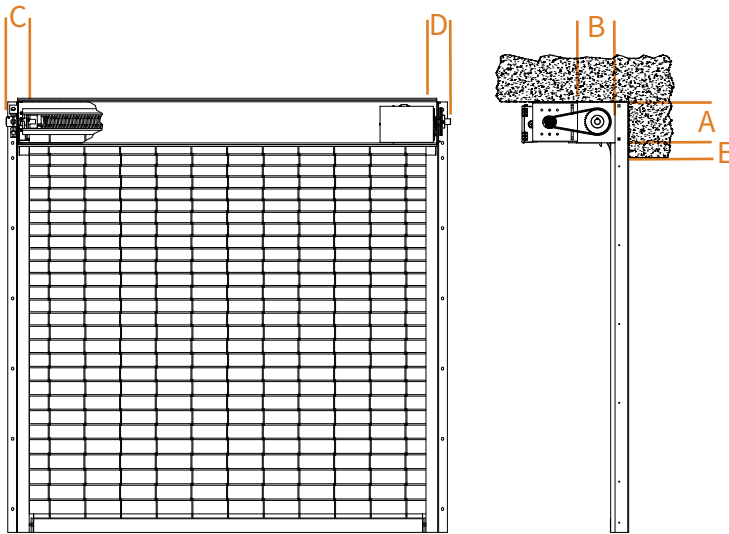

### CURTAIN DESIGNS



Straight

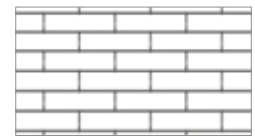

Brick

The dimensions featured on this sheet are provided as a rough guide for planning purposes. Exact dimensions cannot be provided until field conditions and all options are confirmed. Once field conditions are confirmed, please visit our website at [www.cooksondoor.com/drawings](http://www.cooksondoor.com/drawings) to generate custom drawings on demand for your specific opening.

**FACE OF WALL GUIDE CONSTRUCTION OPTIONS**

**STAINLESS STEEL**

**Z GUIDE**

Typically used with masonry wall construction, guides are mounted to the interior or exterior side of the wall.

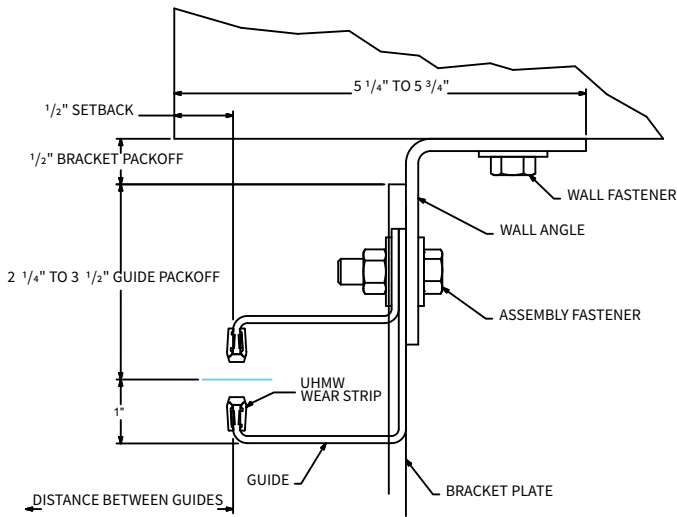

**E GUIDE**

Typically used with steel jambs, guides are mounted to the interior or exterior side of the wall.

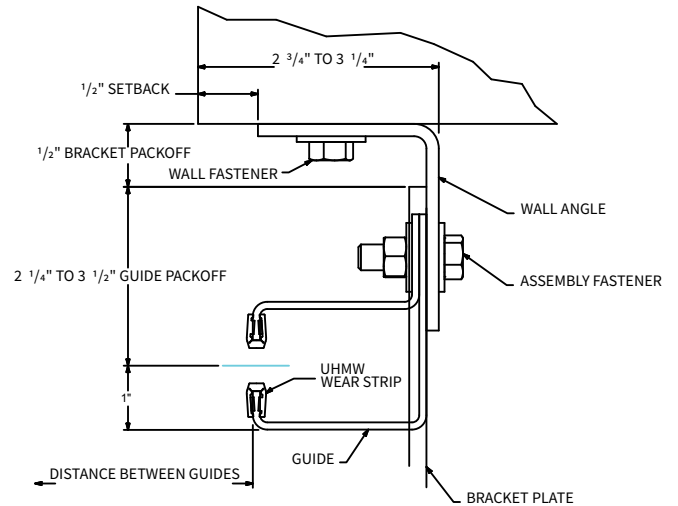

**Z GUIDE TO TUBE**

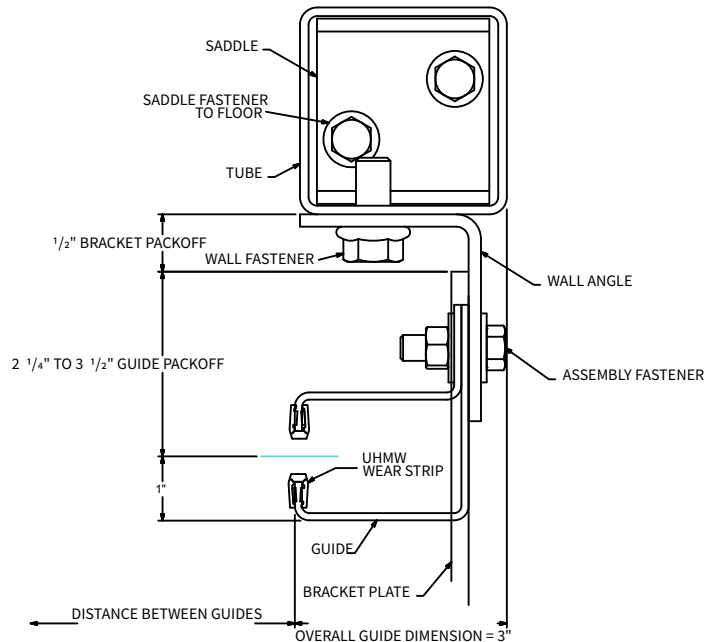
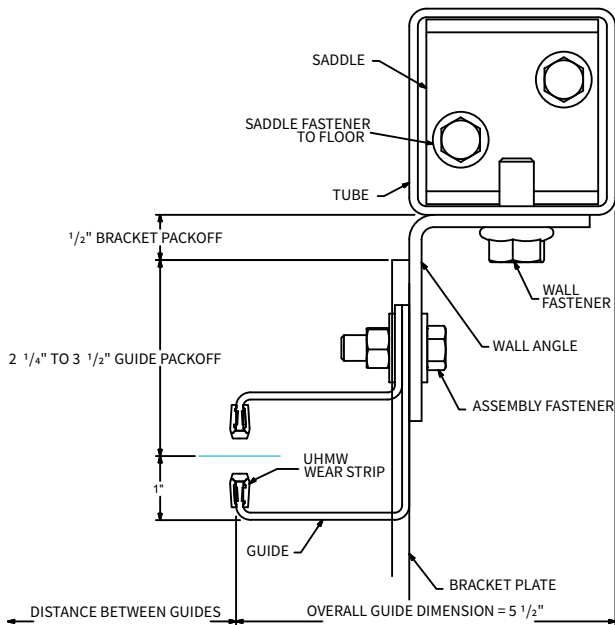

**FACE OF WALL GUIDE CONSTRUCTION OPTIONS**

**ALUMINUM**

**Z GUIDE**

Typically used with masonry wall construction, guides are mounted to the interior or exterior side of the wall.

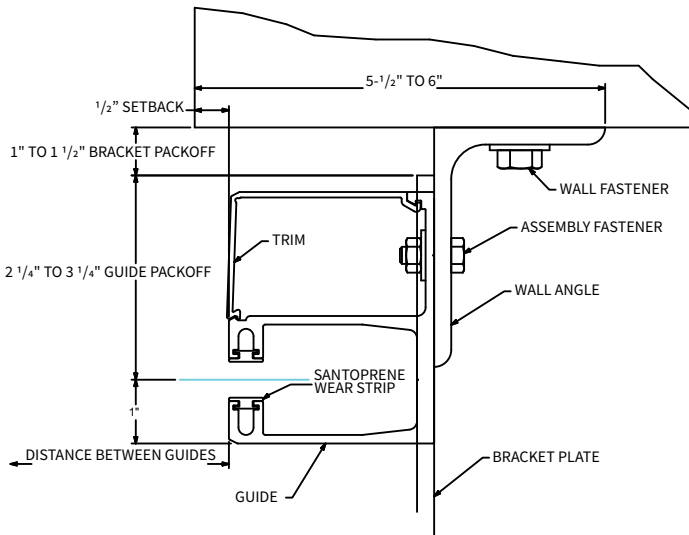

**E GUIDE**

Typically used with steel jambs, guides are mounted to the interior or exterior side of the wall.

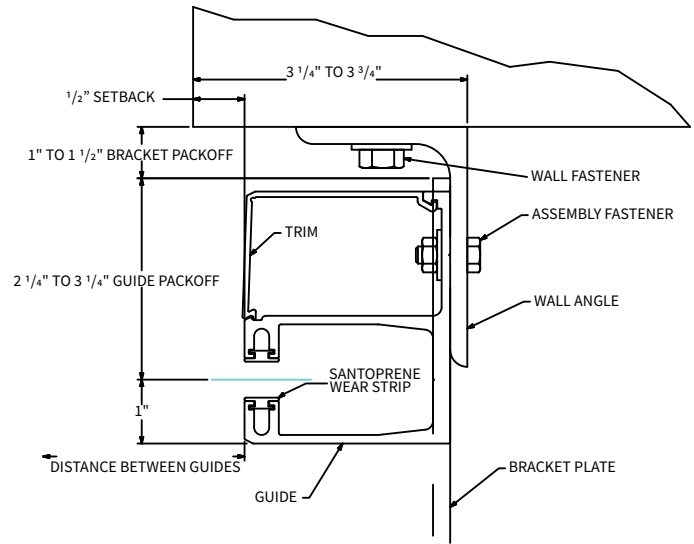

**Z GUIDE TO TUBE**

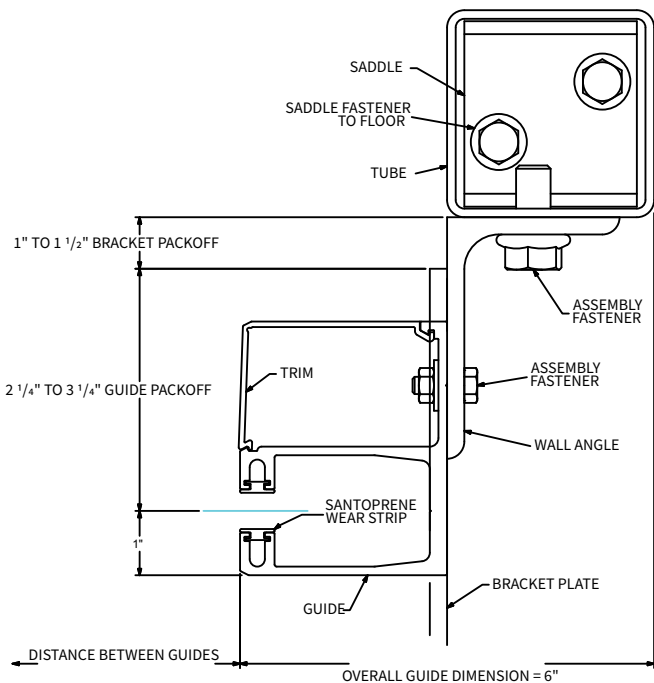

**E GUIDE TO TUBE**

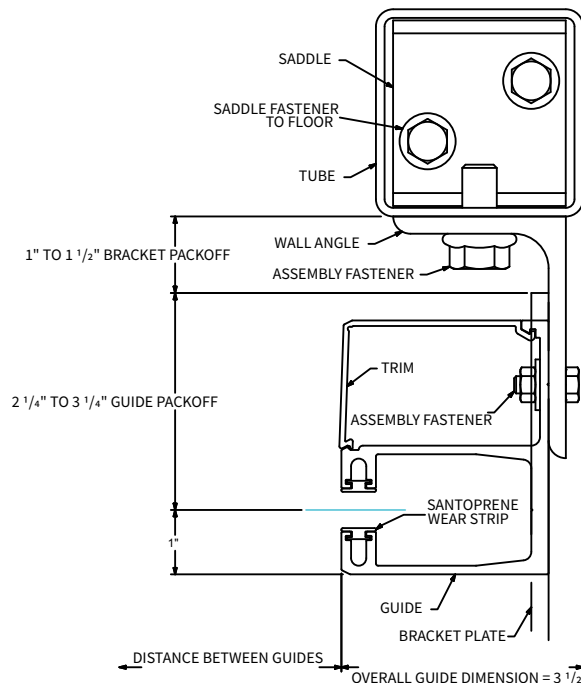

**BETWEEN JAMBS GUIDE CONSTRUCTION OPTIONS**

**ALUMINUM**

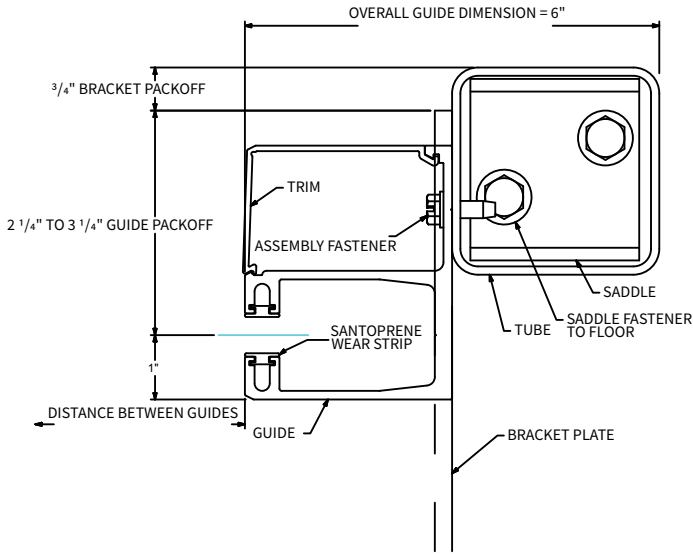

**STAINLESS STEEL**

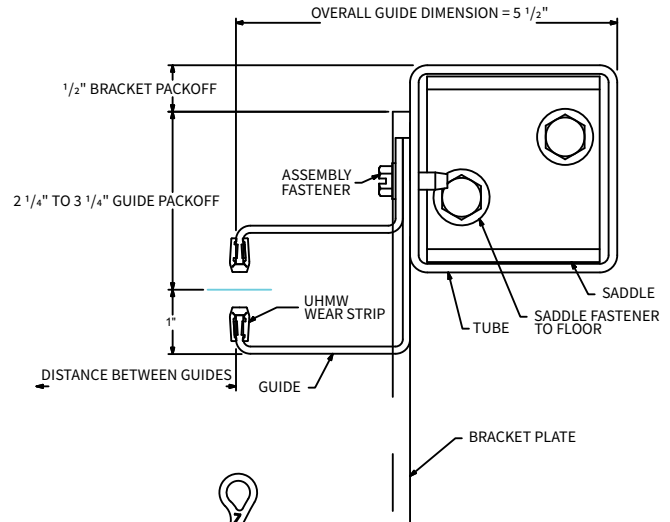

**BOTTOM BAR CONSTRUCTION**

Compact extruded aluminum in mill finish.

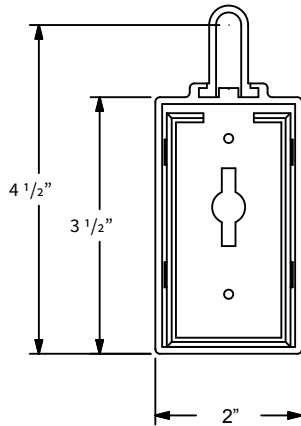

Curtain connection to bottom bar.

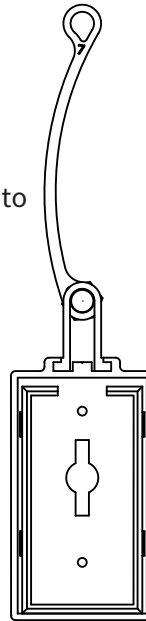

The dimensions featured on this sheet are provided as a rough guide for planning purposes. Exact dimensions cannot be provided until field conditions and all options are confirmed. Once field conditions are confirmed, please visit our website at [www.cooksondoor.com/drawings](http://www.cooksondoor.com/drawings) to generate custom drawings on demand for your specific opening.

**CUSTOM-DESIGNED SOLUTIONS**

Our experienced Architectural Design Support Team can customize our products to fit your specific application.

☎ 877.537.4567 ✉ [arch@cornellcookson.com](mailto:arch@cornellcookson.com)